

The Alzheimer's Disease Impact on Artificial Neural Networks

Maksims Zigunovs
Turība University
Riga, Latvia
maksims.zigunovs@inbox.lv

Abstract - The Alzheimer's Disease main impact on the brain is the memory loss effect. Therefore, in the "neuron world" this makes a disorder of signal impulses and disconnects neurons that causes the neuron death and memory loss. The research main aim is to determine the average loss of signal and develop memory loss prediction models for artificial neuron network. The Izhikevich neural networking model is often used for constructing neuron neural electrical signal modeling. The neuron model signal rhythm and spikes are used as model neuron characteristics for understanding if the system is stable at certain moment and in time. In addition, the electrical signal parameters are used in similar way as they are used in a biological brain. During the research the neural network initial conditions are assumed to be randomly selected in specified the working neuron average sigma I parameters range.

Keywords - Neuron network, Alzheimer's Disease, Neuron synchronization.

I. INTRODUCTION

There are 10^{11} neurons in the human brain. Neurons are unique in the sense that only they can transmit electrical signals over long distances.

From the neuronal level we can go down to cell biophysics and to the molecular biology of gene regulation. In addition, from the neuronal level we can go up to neuronal circuits, to cortical structures, to the entire brain, and finally to the behavior of the organism.

A typical neuron receives inputs from more than 10,000 other neurons through the contacts on its dendritic tree called synapses. The inputs produce electrical transmembrane [1] currents that change the membrane potential of the neuron. Synaptic currents produce changes, called postsynaptic potentials (PSPs).

Small currents produce small PSPs; larger currents produce significant PSPs that can be amplified by the voltage-sensitive channels embedded in the neuronal membrane and lead to the generation of an action potential or spike, an abrupt and transient change of membrane voltage that propagates to other neurons via a long protrusion called an axon.

There are two main different neuron models are being implemented: chemical and electrical models.

The main difference between them besides the main equations of the signal transmission, is the signal reverse direction distribution. The chemical model do not assume it, but electrical does.

The chemical model structure is usually represented by such figures:

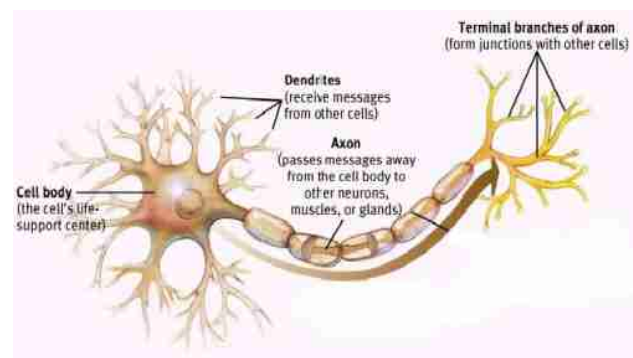

Fig. 1. Neuron chemical model structure.

The electrical model structure is usually represented by such figures:

Online ISSN 2256-070X

<https://doi.org/10.17770/etr2021vol2.6632>

© 2021 Maksims Zigunovs. Published by Rezekne Academy of Technologies.

This is an open access article under the [Creative Commons Attribution 4.0 International License](https://creativecommons.org/licenses/by/4.0/).

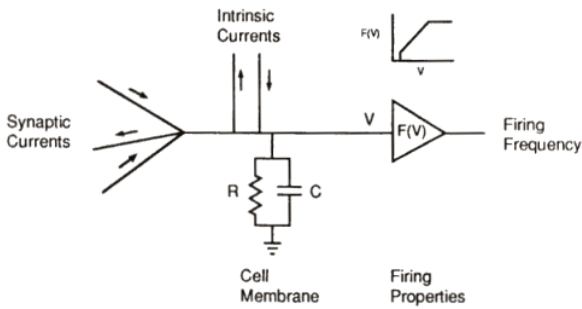

Fig. 2. Neuron electrical model structure.

II. NETWORK MODEL

The chemical neuron model is used within this paper.

The transition between resting and spiking modes could be triggered by intrinsic slow conductance, resulting in the bursting behavior. There could be millions of different electrophysiological mechanisms of excitability and spiking [2]. Fig. 3. demonstrates the general spike plot of the neuron.

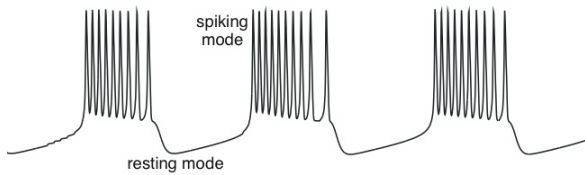

Fig. 3. General neuron spike plot.

III. WAYS TO SIMULATE THE NEURON WORK

There are a lot of ways to simulate the neuron work developed to make adaptive and adaptive response systems.

- Hodgkin-Huxley Model was produced by Hodgkin and Huxley in 1952. The model explains the ionic mechanisms underlying the initiation and propagation of action potentials in the squid giant axon.
- Izhikevich Model is transformed continuous-time Euler's Discretization.
- 3 Rulkov Models can be used in different chaos prediction.
- Courbage–Nekorkin–Vdovin (CNV) Model is quite similar to chaotic Rulkov Model.
- etc.

The Izhikevich Model was chosen to be used for numerical experiments.

A. Alzheimer's Disease Modeling

The Alzheimer's disease problem for the brain is a fast and tending neuron isolation from the brain neural network. It means that during the Alzheimer's disease the brain "loose" cells of memory and analytical skills developed in whole live time. Eventually, some part of neural network

can loose connections to whole neuron clusters even if they produce signals between themselves:

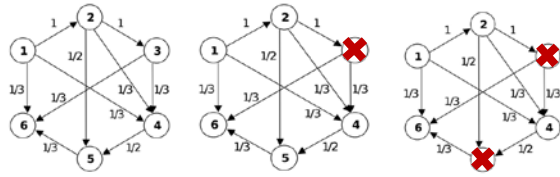

Fig. 4. General exclusion of the neuron from the neuron network.

B. The Izhikevich Model

The Izhikevich Model is originally continuous-time, but Euler discretization with a time step of 1 ms transforms it into the map.

There are several parameters needed for making Izhikevich neural map-based neural model calculations for calculating the membrane voltage difference between inside and outside) sides and additional variable described as follows:

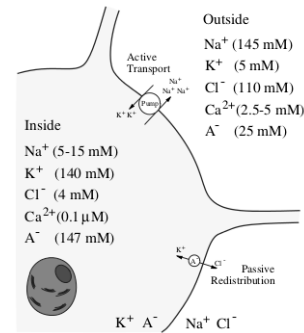

Fig. 5. Structure of the neuron that is assumed as general for the experiments.

The main equation of the Izhikevich model combines values of the neuron collectable voltage in time and neuron output membrane threshold that works similar to electrical conductor and can be describes as follows:

$$v(t+1) = F[v(t), I - u(t)],$$

$$u(t+1) = \begin{cases} u(t) + a \cdot [bv(t) - u(t)], & \text{if } v(t) < 30, \\ u(t) + d, & \text{if } v(t) \geq 30, \end{cases}$$

$$F(v, I) = \begin{cases} \min(0.04v^2 + 6v + 140 + I, 30), & \text{if } v < 30, \\ c, & \text{if } v \geq 30. \end{cases} \quad (1)$$

, where v [mV] is membrane voltage (potential), u [mV] represents a membrane recovery variable, which accounts for the activation of K^+ ionic currents and inactivation of Na^+ ionic currents is additional variable depends on membrane voltage, I (synaptic currents or injected dc-currents) is electricity source connected from outside, a , b , c and d are just neuron parameters.

The parameter a - describes the time scale of the recovery variable u . Smaller values result in slower recovery. A typical value is $a=0,02$.

The parameter b - describes the sensitivity of the recovery variable u to the subthreshold fluctuations of the membrane potential v . Greater values couple v and u more strongly resulting in possible subthreshold oscillations and low-threshold spiking dynamics. A typical value is $b=0.2$.

The parameter c - describes the after-spike reset value of the membrane potential v caused by the fast high-threshold K^+ conductances. A typical value is $c=-65mV$.

The parameter d - describes after-spike reset of the recovery variable u caused by slow high-threshold Na^+ and K^+ conductances. A typical value is $d=2$.

There are another equations that represents same ones:

$$\begin{cases} C_m \frac{dV_m}{dt} = k(V_m - V_r)(V_m - V_t) - U_m + I_b + I_{syn} \\ \frac{dU_m}{dt} = a(b(V_m - V_r) - U_m) \end{cases}$$

if $V_m \geq V_{peak}$, then

$$\begin{cases} V_m = c \\ U_m = U_m + d \end{cases} \quad (2)$$

For one of variations of the neuron parameters values the v and u plot would be Fig. 6 for predefined parameter values ($a = 0.02$, $b = 0.25$, $c = -55$, $d = 0$, $I = 0.8$):

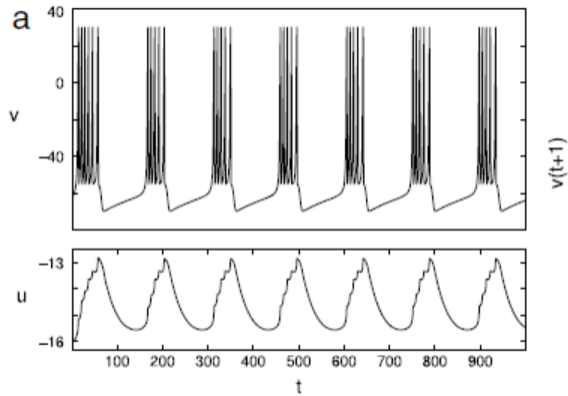

Fig. 6. Neuron v and u values.

IV. NUMERICAL EXPERIMENTS

For numerical experiments the 6 neuron model was used implementing the connectivity matrix that describes the way how each neuron is connected to other neurons in the neuron network model:

$$C = \begin{pmatrix} 0 & 1 & 0 & 1/3 & 0 & 1/3 \\ 0 & -1 & 1 & 1/3 & 1/2 & 0 \\ 0 & 0 & -1 & 1/3 & 0 & 1/3 \\ 0 & 0 & 0 & -1 & 1/2 & 0 \\ 0 & 0 & 0 & 0 & -1 & 1/3 \\ 0 & 0 & 0 & 0 & 0 & -1 \end{pmatrix}$$

Fig. 7. Neuron network connectivity matrix.

The neural network for the corresponding connectivity matrix is following:

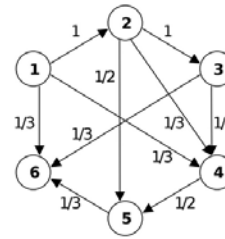

Fig. 8. Neuron network structural model.

The numerical experiments assume neural network analysis that involves Fast Fourier Transformation, Synchronization degree, network coherence, and phase synchronization degree.

The Synchronization degree is described as follows:

$$\sigma = \sqrt{\frac{1}{T} \int_{t=t_0}^T \sigma(t) dt} \quad (3)$$

$$\sigma(t) = \frac{1}{N} \sum_{n=1}^N [x_n(t)]^2 - \left[\frac{1}{N} \sum_{n=1}^N x_n(t) \right]^2 \quad (4)$$

, where T is the duration of the time series, t_0 is the duration of transients, N is the number of nodes ($n=1,2,\dots,N$).

The network coherence is described as following equations:

$$H = \frac{1}{N} \sum_{n=1}^N h_n^2 - \left(\frac{1}{N} \sum_{n=1}^N h_n \right)^2 \quad (5)$$

$$h_n = \sqrt{\frac{1}{M-m_0+1} \sum_{m=m_0}^M R_m(n)} \quad (6)$$

, where R_m is inter-spike interval (ISI) between m -th and $(m+1)$ -th spike, M is the number of spikes ($m=1,2,\dots,M$), m_0 is the number of transient spikes.

The Phase synchronization degree is described as following equations:

$$\Phi = \sqrt{\frac{1}{M} \sum_{m=1}^M \psi_m} \quad (7)$$

$$\psi_m = \frac{1}{N} \sum_{n=1}^N \varphi_n^2 - \left(\frac{1}{N} \sum_{n=1}^N \varphi_n \right)^2 \quad (8)$$

$$\varphi_n = \tan^{-1} \left(\frac{dy_n/dx_n}{dx_n/dt} \right) - \tan^{-1} \left(\frac{dy_1/dx_1}{dx_1/dt} \right) \quad (9)$$

, where φ is the phase difference.

When a neuron is isolated it still works, but without any connections to other neurons. It means that it is possible to

create full neuron set rhythm plot to find out periodic value behavior.

The simplest way to analyze a neuron network is to calculate neuron synchronization plot line. Generally, as more time the neuron network working process is simulated as more synchronized neurons become. Literary, it means as more straight the synchronization plot line and more synchronized the neuron network is [3].

For example, the Fig. 8. neuron network without neuron isolations synchronization plot looks as follows (N – simulation time step):

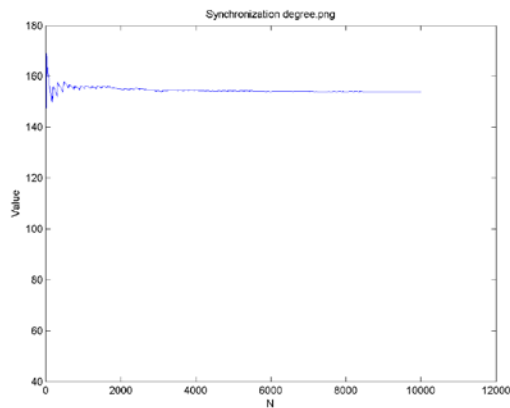

Fig. 9. Example network synchronization plot.

The same network U values plot is following:

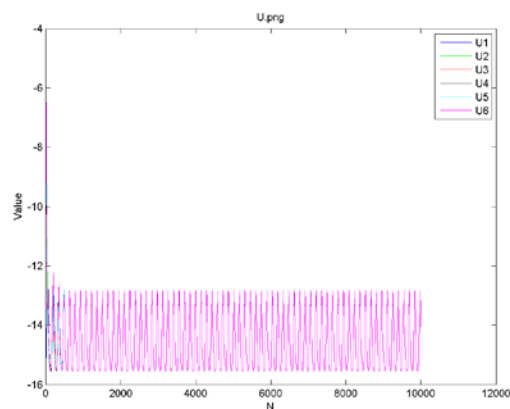

Fig. 10. Example network U values.

In case of Fig. 4. case with isolated neurons the synchronization plot line and U values plot line look as follows:

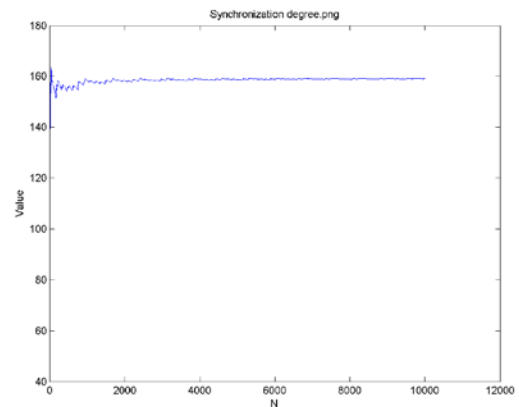

Fig. 11. Example network synchronization plot.

The same network U values plot is following:

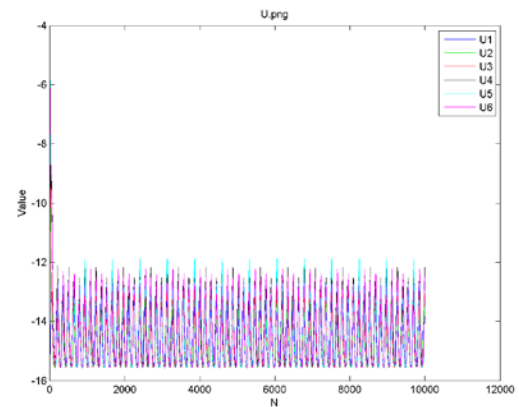

Fig. 12. Example network U values.

As it is seen from graphical results the second network case is less synchronized in comparison to the first one as well as U values are quite periodic, but values are significantly changes in time, that makes it clear that value changes (because of a lot of factors) can provide changeable states of the neuron network.

V. CONCLUSIONS

1. There are several useful neuron work simulation models.
2. Several factors such as neuron signal delay and neuron isolation have to present in Alzheimer's Disease problem analyze solutions.
3. The Izhikevich Model gives stable results during calculations.
4. The neuron signal receiving delay make big impact the overall neuron network system behavior.
5. Neuron synchronization level impacts only the neural network stabilized state process time.
6. The research made it clear there is a lot of next steps to be done to analyze an effect on the neuron network overall level/percentage (if applicable) of memorized information.

REFERENCES

- [1] A.L. Hodgkin, A.F. Huxley, "A quantitative description of membrane current and its applications to conduction and excitation in nerve", *The Journal of Physiology*, vol. 117, no. 4, pp. 500 – 544, 1952.
- [2] B. Ilbarz, J.M. Casado, M.A.F. Sanjuan, "Map – based models in neuronal dynamics", *Physics Reports*, vol. 501, no. 1 – 2, pp. 1 – 74, 2011.
- [3] N.F. Rulkov, "Modeling of spiking – bursting neural behavior using two – dimensional map", *Physical Review*, vo. 64, no. 4, Article ID 041922, 2002.